

AKAI

Makes Sense



10kg Top Load Washing Machine

INSTRUCTION MANUAL

MODEL: AK-10KGLW

After Sales Support

☎ (AU) 1300 886 649 (NZ) 0800 836 761 | ✉ info@tempo.org



E209

Contents

- 03 General Safety Instructions**
- 07 Product Overview**
- 08 Getting Started: Installation**
- 12 Features**
- 14 Instructions**
- 21 FAQs and Troubleshooting**
- 23 Other Useful Information**

General Safety Instructions

IMPORTANT SAFETY INSTRUCTIONS READ CAREFULLY AND KEEP FOR FUTURE REFERENCE

Read this manual thoroughly before first use, even if you are familiar with this type of product. The safety precautions enclosed herein reduce the risk of fire, electric shock and injury when correctly adhered to.

Keep the manual in a safe place for future reference, along with the completed warranty card and purchase receipt. If applicable, pass these instructions on to the next owner of the appliance.

Always follow basic safety precautions and accident prevention measures when using an electrical appliance, including the following:



Warning

This heading indicates that there is a serious risk of injury if you do not adhere to the warning(s).



Caution

This heading indicates that care should be taken to avoid injury to persons or damage to property.



A tick in a circle accompanies a measure or action that you should do or follow.



A cross in a circle accompanies a measure or action that you should NOT do.

Electrical safety

- Before connecting and turning on the washing machine, ensure the electrical voltage and circuit frequency correspond to those indicated on the appliance.
- Only connect the washing machine to a grounded (earthed) electrical outlet.
- Do not insert any objects into the appliance.
- Do not kink or damage the power cord, and position it out of the way so no one steps on or places anything on the cord or against it.
- Do not overload the wall outlet. Overloading can result in fire or electric shock.
- If the supply cord is damaged, it must be replaced by the manufacturer or its service agent or a similarly qualified person in order to avoid a hazard.
- Never use this washing machine with a power adaptor or an extension cord.
- Unplug the washing machine from the power supply before cleaning, servicing, maintenance or moving the appliance. Pull by the plug, not by the cord.
- After use, always unplug the appliance and turn off the water.
- **WARNING:** All electrical work must be done in accordance with local and national electrical codes as applicable and should be undertaken by licenced and qualified persons only.

General Safety Instructions (Cont.)

Installation

- Install the washing machine on a flat surface to avoid overturning during use. If the machine must be placed on carpet, make sure any ventilation openings in the base are not obstructed.
- Install the washing machine so that there is a distance of at least 200mm between the appliance enclosure and any external heat sources, such as appliances containing heating elements.
- Connect the washing machine to the water mains using new hose sets. Do not reuse old hose sets. The required water pressure is 0.03MPa (min.) to 0.8MPa (max.).
- Make sure that all water and electrical connections are made by qualified personnel only, observing local safety regulations and following the manufacturer's instructions (see "Getting Started: Installation" on pages 8 to 11).
- Improper installation may result in the risk of fire, electric shock and/or injury. We assume no liability for any eventual damages caused by improper installation.

Usage conditions and restrictions

- The appliance is designed for private domestic use only. It is not suitable for commercial or trade use. The appliance has a capacity (max. weight of dry wash load) of 10kg.
- Do not operate the appliance outdoors.
- This appliance is not intended for use by persons (including children) with reduced physical, sensory or mental capabilities, or lack of experience and knowledge, unless they have been given supervision or instruction concerning use of the appliance by a person responsible for their safety.
- Children should be supervised to ensure they do not play with the appliance.
- Before loading the machine, always ensure no pet or young child has climbed into it.
- Make sure all pockets of clothing to be washed are empty. Hard, sharp objects such as coins, safety pins, bra wires, nails, screws or stones can cause extensive damage to the appliance and block the pump.
- Any damage or malfunction resulting from foreign objects is not covered by your warranty and may lead to expensive repairs. We assume no liability for any eventual damages caused by improper or faulty use.

Cleaning and maintenance

- Before cleaning or carrying out maintenance, always unplug the appliance from the power supply.
- Except for the filters that require regular cleaning, the unit has no user-serviceable parts contained within. Do not attempt to repair, disassemble or modify it. Repairs made by inexperienced or unqualified persons may cause injury and/or make more serious repairs to the appliance necessary.
- **CAUTION:** After each wash, check and clean the lint filter inside the drum. Also check and clean the lint filter at the back of the machine next to the drain hose outlet on a regular basis.
- This appliance should only be serviced by an authorised service centre, and only genuine spare parts should be used. Contact our after sales support line for advice.

General Safety Instructions (Cont.)

Warnings

Do not let children climb into the washing machine or peer into the rotating spin barrel.



Do not wash clothes that have residue of flammable materials.



Do not use the appliance if the power cord or plug is damaged to avoid an electric shock, short circuit or fire.



Regularly clean the power plug to remove dust and dirt and avoid contact failure.



Turn the machine off before pulling out the plug from the socket if the machine is not in use.

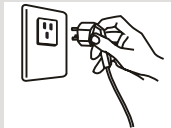

Do not place any lit candles or cigarettes on top of the washing machine.



Insert the power plug securely.

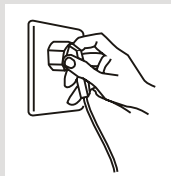

Use a 230-240V AC power source.

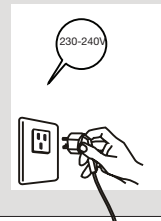

General Safety Instructions (Cont.)

To avoid electric shock, fire and malfunction, do not install this machine in a damp place.



No dampness



Do not pull out or insert the plug with wet hands to avoid electric shock.

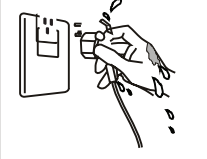



No wet hands



Cautions



Ensure the water inlet hoses are connected and the taps are turned on before washing a load.



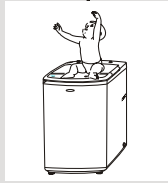

Do not allow children to lay or sit on top of the washing machine.





Do not change the power cord. If it needs changing, contact a qualified electrician or call the after sales support line.



Do not wash jackets, raincoats, fishing coats and similar clothes in the washing machine.



Do not pull the power cord when removing the plug.



The water temperature should not exceed 60°C when washing with warm water.

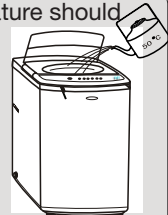

Product Overview



Top load washing machine

- 1 Lid
- 2 Level indicator
- 3 Softener dispenser
- 4 Control panel
- 5 Housing
- 6 Adjustable leg
- 7 Rollers (one on each back corner)
- 8 Handle (one on each side)
- 9 Wash/spin tub
- 10 Detergent box
- 11 Cold and hot water connections

Accessories

- 12 Hot water supply hose
- 13 Cold water supply hose
- 14 Drain hose

Not shown: Base cover and screw for attaching it to the unit (see page 8)

C Documentation (not shown)

- Instruction manual
- Quick start guide
- Warranty certificate

Getting Started: Installation

Unpacking

- This product has been packaged to protect it against transportation damage. Keep the original packaging carton in a safe place. It will help prevent any damage if the product needs to be transported in the future. In the event that it is to be disposed of, please recycle it and all other packaging materials where possible.
- Plastic wrapping can be a suffocation hazard for babies and young children, so ensure all packaging materials are out of their reach and disposed of safely.
- Unwind the power cord to its full length and inspect it for damage. Do not use the appliance if the appliance or its cord has been damaged or is not working properly. In case of damage, contact our after sales support centre for advice on examination, repair or return of the damaged product.
- Read this manual to familiarise yourself with all the parts and operating principles of the washing machine. Pay particular attention to the safety instructions on the previous pages.

Installing the base cover

- Make sure the power cord is unplugged from the mains supply.
- Place some padding (such as a soft mat, blanket or thick towel) on the floor and gently lay the washing machine on the padding, back side down. Take care not to dent the housing.
- Insert the base cover into the hooks of the leg, pushing it straight until it reaches into the front hooks.
- Fasten the base cover with the supplied screw(s).
- Carefully set the washer upright.

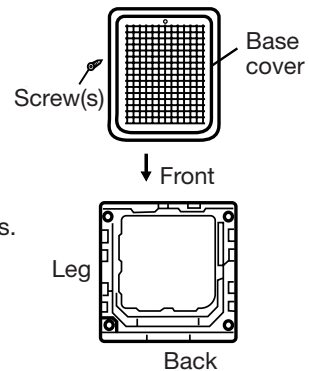

Levelling the washer

- Install the washer on a stable and level surface, in a dry location, out of sunlight.
- The inbuilt levelling indicator (see page 7) will help you determine whether levelling is necessary. If so, adjust the adjustable leg (at the front right side of the machine), as illustrated, right. The maximum permissible inclination of the supporting surface is 2°.

CAUTION: Installing the washer on a carpeted floor may cause vibration issues. If you must install it on carpet, make sure not to block any ventilation openings on the bottom of the washer.

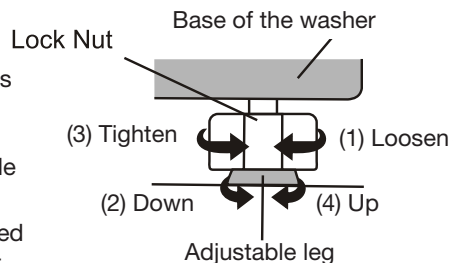

Getting Started: Installation (Cont.)

Connecting the water inlet hoses

Install the water inlet hoses to your hot and cold water taps, as described below.

- Check and ensure that the sealing washers are firmly in place.
- Attach the straight end of the hose to your water taps. Make sure to attach the hot water supply hose (with **red** markings) to the hot water tap and the cold water supply hose (with **blue** markings) to the cold water tap.
- Tighten the coupling nuts securely by hand, as illustrated below (the sealing washer is part of and located inside the tap end).

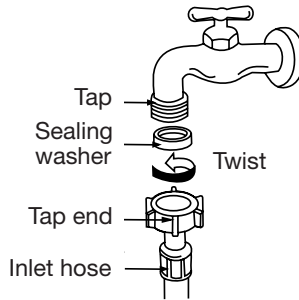

- Attach the curved end of the hose to the corresponding inlet valve of the washer.
- Tighten the coupling nuts securely by hand, as illustrated below.
- Tighten the nut by turning it clockwise while holding the hose. (To detach the water supply hose, turn the nut anticlockwise after turning the tap off.)



- Turn on the taps and check for leaks. Tighten the coupling nuts firmly if there is any leakage. If your water pressure is strong, close the water tap completely, then open it slightly.

IMPORTANT!

- Both the hot water and cold water hoses must be connected to your taps.
- Make sure your hot water from the tap is no hotter than 60°C.

Getting Started: Installation (Cont.)

⚠ CAUTION: When tightening the clamping nut, take care not to damage the water inlet valve joint. Apply force evenly and do not twist the water inlet valve.

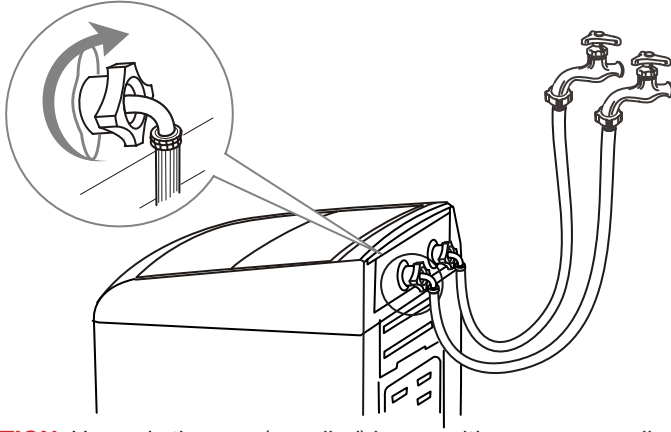

⚠ CAUTION: Use only the new (supplied) hoses with your new appliance. Do not use a hose from an existing machine, or one that has been used previously.

⚠ CAUTION: In the event that the hoses are too short for your set-up, please seek advice from your local washing machine store to purchase a longer hose.

Installing the drain hose

- The drain hose and drain pump filter are located at the back of the machine, as illustrated below, left.
- Pinching the two bands of the clamp on the drain hose, connect it to the drain hose connection at the back of the washer, as illustrated below.
- When the washer is in use, put the drain hose into a drain spout (or into a sink/tub), as illustrated on the opposite page.

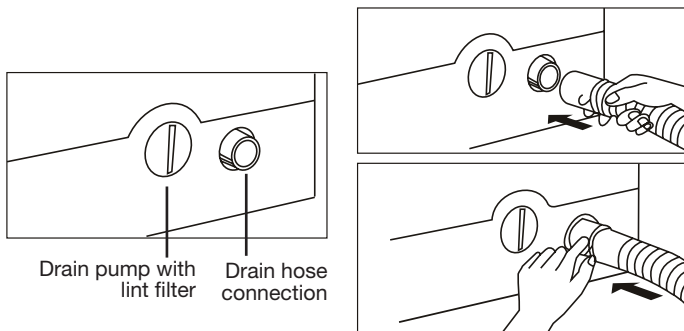

Getting Started: Installation (Cont.)

CAUTION!

- While the washer is in use, make sure the height of the drain hose is at least 80cm, otherwise the washer will not work well, or the water may flow out in the course of washing. Also ensure the drain hose is not higher than 120cm above ground, otherwise the washer will not drain water well.
- Never lay down the drain hose, as water will be discharged.
- Be sure the drain hose is properly routed so it will not kink or lift off the sink.

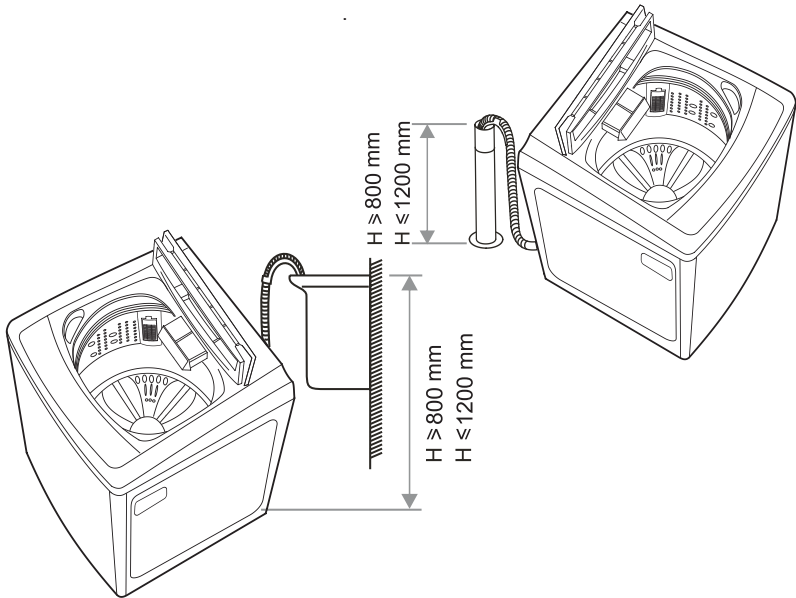

Using the rollers

The washing machine is equipped with two rollers at the back that you can use to move the machine more easily. Tilt the washing machine by about 30 degrees and push forward, or pull backward, while holding the machine securely on both sides with your hands, as illustrated below.

Do not move the machine on the rollers on uneven ground, which can damage the rollers.

CAUTION: Take care of your back! Do not tilt the washing machine too much, which could cause injury.

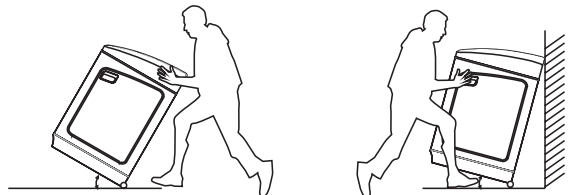

Features

The control panel

Detergent indication

- These indicate how much powder detergent to use.
- See 'Detergent and load recommendations', page 15, for details.

Time and preset indicators

This indicator shows the remaining time during washing.

(E.g.) Remaining time is 20 minutes

20

When setting soak and wash processes, this indicator shows the time you set.

(E.g.) Washing time is 10 minutes

10

This indicator shows during presetting when the washing will be finished.

(E.g.) Finish washing 2 hours later

2

When abnormal conditions occur, an error warning will appear here.

(E.g.) Water does not flow

E1

Water level button

- You can choose the appropriate water level that matches the load size.
- Different water levels for washing or rinsing are optional.
- See 'Setting the water level ...', page 19, for details.



Preset / Ultrasonic button

- Press this button to preset the finish time of the washing (not applicable for the **Delicate** program).
- To select or cancel the **Ultrasonic** function, press and hold the button until the **Ultrasonic** light is on or off. See page 20 for details.

Program/Child lock button

- Press this button to choose the washing program: the relevant indicator light will start flashing.
- This button is also used to set the child lock function. See 'Child lock', page 20, for details.
- The machine automatically sets certain washing processes for the **Normal / Heavy Duty / Custom** and **Wool** wash programs. See page 20 for details.

Features (Cont.)

Rinse indication

- This indicator shows the number of rinses.

(E.g.) Rinsing 2 times

2

Spin indication

- This indicator shows the spin time in minutes (maximum 9 minutes).

Spinning time is 9 minutes

9

Start/Pause button

- Press this button to start the washer operation.
- During operation, press this button to stop the washer temporarily; press it again to restart the washer operation.

NOTE: This is not a **Cancel** button.

Power button

- Press this button to switch the power on; press it again to switch the power off.
- At the end of a washing program, the power will be switched off automatically after 5 seconds.
- If you leave the washer switched on without starting the operation, the power will be switched off automatically after 10 minutes of inactivity.



Process buttons

- Press these buttons to set various wash processes. See 'Setting the water level ...', page 19, for details.
- Press the **Soak / Variable Wash** button before the start to set a soak time of up to 40 minutes (not applicable for the **Delicate** and **Blanket** programs). See page 19.

Temp. button

- Press this button if you want to choose the water temperature. See 'Hot / cold / warm water wash', page 19 for details.

Instructions

Before you start washing

- A Make sure the washer is stable and level. The inbuilt level indicator (see page 7) will help you determine whether levelling is necessary. If so, adjust the adjustable leg (front right) to stabilise the washer (see page 8).
 - B Make sure the water inlet hoses are properly installed (see page 9).
 - C Plug the machine into a nearby power point.
 - D Open the water taps.
 - E Make sure the drain hose is properly installed. Hang the upper end of the hose over the laundry sink or into a drain spout (see page 10).
- F Before using the washing machine for the first time, run a complete cycle without laundry items.**

Select the **Normal** program and run the machine until the end of the program.

Normal usage

1. Before washing, remove any coins, keys and other hard items from pockets. Close any zippers to prevent damaging your clothes and the wash tub. Brush dirt and sand off clothes and turn pockets inside out.
2. Sort your washing into appropriate loads: whites, coloureds, cottons, delicates, heavily soiled, etc. Place delicate items into a wash bag for protection.
3. Load your washing items uniformly in the tub.
4. Add washing detergent (see opposite for details).
5. Press the **Power** button.
6. Refer to the Program Selection Guide (opposite) and select a suitable wash program. For the **Normal** and **Heavy Duty** programs, the machine will automatically choose the correct water power and level, wash and spin time and rinse type; for the **Custom** and **Wool** programs, the machine will automatically select the correct water level. Other parameters can be set individually (see page 16).
7. Close the lid and press the **Start/Pause** button. (If the washer lid is not closed properly, the washer will sound an alarm and stop working before spinning.)
8. At the end of the wash, remove your washing, unplug the power plug from the wall outlet and close the water taps. Leave the lid open until the interior has dried.

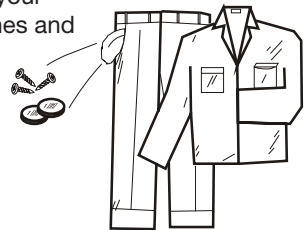
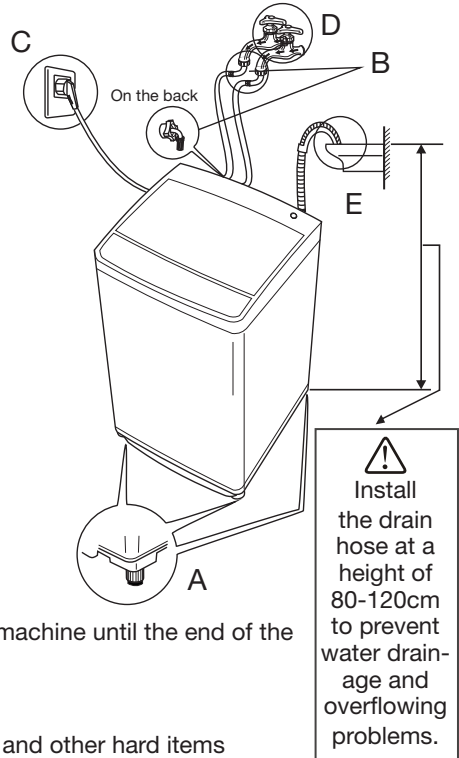

Instructions (Cont.)

Program selection guide

Program	Suitable items	Default settings for individual wash processes		
		Washing time * (minutes)	Rinse type	Spin time (minutes)
Normal **	Normally soiled clothing and other items	5–40	2 x Water saver rinse 4 x Shower rinse	5–26
Custom	Dependent on the custom settings	10	2x Water saver rinse	5
Delicate	Delicate fabrics, lingerie	6	2x Water saver rinse	2
Heavy Duty	Heavily soiled cottons, workwear	7–14	2x Water saver rinse	7–8
Blanket	Blanket or bulky items	12	2x Water saver rinse	8
Wool	Delicates, knitwear	10	2x Water saver rinse	2

* Total program times differ and depend on the weight of the wash load and water level.

** When the water level of the **Normal** program is set to 8, the program has a default setting of 90L of **warm** water; all other programs have cold water as a default (water temperature is adjustable, see page 19).

Detergent and load recommendations

- We suggest you use detergent in the amounts recommended below. Too little will give poor washing results, but too much will affect rinse performance and may cause overflow of suds, which could interfere with machine operation.

CAUTION: Do not overfill detergent.

- Add detergent into the detergent box or put it directly into the tub (see page 18).
- Dilute fabric softener with a little water and carefully add it to the softener dispenser on the balance ring for dispersion through the final rinse.

Water level indicator								
Water level	1	2	3	4	5	6	7	8
Water volume	28L	35L	44L	53L	65L	71L	81L	90L
Wash capacity (kg)	Below 1	1–2.5	2.5–3.5	3.5–5	5–6	6–7.5	7.5–8.5	8.5–9
Detergent indicator								
Amount of powder detergent (g)	25–35		35–53		53–71		71–90	
Liquid detergent	Follow the recommendations on the detergent packaging.							

Instructions (Cont.)

Customising a program

This washing machine is equipped with a fuzzy logic function that automatically chooses certain wash cycle processes for the **Normal**, **Heavy Duty**, **Custom** and **Wool** programs. You do not have to adjust them yourself, however, if you want to adjust these values yourself, proceed as follows:

1. Prepare your washing according to points 1 to 4 on page 14.
2. Press the **Power** button, then press the **Program** button to select the washing program, e.g. **Normal**, **Heavy Duty**.
3. Press the appropriate process button to select the process and time you want to adjust. The relevant indicator light will illuminate when the option is selected.

- SOAK time options

0 → 5 → 10 → → 35 → 40 Minutes (Soak time cannot be adjusted for the **Delicate** and **Blanket** programs.)

- WASH time options

0 → 1 → 2 → → 19 → 20 Minutes

- RINSE options

0 → 1 → 2 → → 4 (The number is the number of rinses.)

- SPIN time options

0 → 1 → 2 → → 8 → 9 Minutes (For the **Delicate** program, spin time can only be adjusted up to 3 minutes, as illustrated.)

0 → 1 → 2 → 3 Minutes (**Delicate**)

- PRESET time options

6 → 7 → 24 → 0 → 1 → 2 (hours) → 3 → 4 → 5

4. Press the **Water Level** button and choose an appropriate water level.
5. Close the lid and press the **Start/Pause** button for the washing program to start.
6. At the end of the washing program, a buzzer will sound to alert you that the program has finished before the power is shut off automatically.
7. Close the water taps and unplug the power plug from the wall outlet.
8. If you want to use a particular customised program on a regular basis, you can program it to the machine's memory for easy access the next time you want to use the same program. See 'Memory function', page 20, for instructions.

Instructions (Cont.)

The blanket program

Use this program for washing blankets or other bulky items. It will automatically select the highest water level (90L), but you can adjust this manually down to 62L according to the size of your bulky item(s).

1. Press the **Power** button and open the washer lid.
2. Press the **Program** button repeatedly until the indicator for the **Blanket** program flashes.
3. Dissolve an appropriate amount of washing detergent with a little lukewarm water, then pour the detergent solution directly into the tub of the washing machine.
4. Fold up the blanket and put it into the washing tub, as illustrated below.

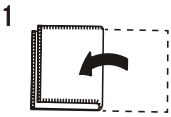

1
Fold in two by the long side



2
Fold 4 times in the same direction

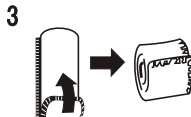

3
Roll up the blanket.

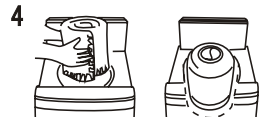

4
Put it into the wash tub with the edge downwards

5. Close the washer lid.
6. Press the **Start / Pause** button for the washing program to start.
7. At the end of the washing program, a buzzer will sound to alert you that the program has finished before the power is shut off automatically.
8. Close the water taps and unplug the power plug from the wall outlet.
9. We recommend cleaning the lint filter after washing a blanket (see page 23 for instructions).

NOTE: If you notice that the blanket floats up during the wash, press the **Start/Pause** button, the washer will stop working temporarily. Push the blanket down and press the **Start/Pause** button again to continue washing.

Selecting a wash cycle process

On occasion you may want to select a single wash cycle process (or two processes) instead of a complete program. For example, you may want to spin clothes that got wet from rain while hanging on the line, or rinse and spin clothes washed by hand.

- **To set a spin cycle only**, set the WASH time and RINSE options to “0” and then select a SPIN time (from 0-9 minutes). Then proceed as described opposite.
- **To set a rinse and spin cycle**, set the WASH time to “0”, then select a RINSE option (from 1 to 4) and then the SPIN time (from 0-9 minutes). Then proceed as described opposite.

Instructions (Cont.)

Preset timer (delayed washing)

This washing machine has a 0–24 hour preset function, which you can set to determine the time when the washing program will finish. (It is, in effect, similar to a ‘delayed start’ function, but you set the time period after which you want the wash to finish rather than to start.)

NOTES: * The Preset function is not available for the **Delicate** program.

* To avoid water leakage when using this function, make sure the water taps are open, the drain hose is properly installed and the washing load and detergent are properly prepared.

1. Put your washing in the machine, loading items uniformly in the tub.
2. Press the **Power** button.
3. Select the required **Program** and process, and any other **Water Level, Temperature** and **Ultrasonic**, if required.
4. Press the **Preset** button to select the desired time period (in hours) for the wash to finish.
5. Select the water level, if necessary.
6. Add any detergents (see below and page 15 for details).
7. Close the washer lid and press the **Start/Pause** button.
8. After setting the **Preset**, the corresponding light will illuminate and all other lights will be switched off about one minute later. (If you set the child lock, the **Child Lock** light will be on.)
9. To check the preset program, press any button (except for the **Power** button); the program will be indicated for 5 seconds. During these 5 seconds you can press the **Water Level** button and set the water level.
10. To cancel the preset, shut off the power.
11. To change the preset time, first cancel the preset, then set it again.

Adding detergent to a preset wash

When using the delayed wash, we recommend you use powder detergent. Do not add detergent directly to the wash tub ahead of the wash time, but follow the instructions below:

- **Washing detergent:** either put detergent into the detergent box or, if you prefer to put it directly into the wash tub, wrap the powder in a small cloth.
- **Fabric softener:** dilute the softener with twice the amount of water, then pour the solution into the softener dispenser.

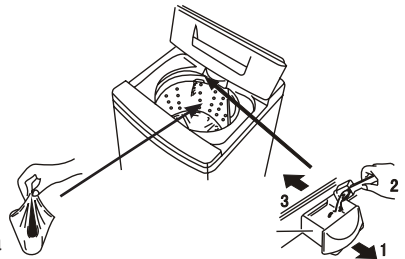

Instructions (Cont.)

Other functions

Hot / cold / warm water wash

This top load washing machine must be connected to both a cold and a hot water tap. You can then set it to use either just cold water for a cold water wash, or just hot water for a hot water wash, or both hot and cold water for a warm water wash.

To select the wash temperature, press the **Temperature** button.

- **Cold wash:** the corresponding indicator light is on.
- **Hot wash:** the corresponding indicator light is on.
- **Warm wash:** both the **Cold** and **Hot** wash indicator lights are on.

Water power

The water power affects the pause time of the pulsator and hence the intensity of the wash. It is automatically selected for the wash and rinse process, however, you can also adjust it yourself (except for the **Delicate** and **Blanket** programs). To adjust the water power level:

- Press the **Start/Pause** button, then press the **Soak/Variable Wash** button: the display will show "H0".
- Press the **Soak/Variable Wash** button again, repeatedly, to increase the water power level from "H1", "H2", "H3" to the strongest, "H4".
- Press the **Soak/Variable Wash** button again, repeatedly, to decrease the water power level from "L1", "L2", "L3" to the weakest: "L4".

Setting the water level and other processes

You can set the water level for wash and rinse processes. For example, if you are sensitive to detergent residues in your washing, you may want to select a higher water level for rinsing.

To set different water levels:

- Press the **Wash** button until the **Wash** light flashes; press the **Water Level** button to choose the appropriate water level; press the **Wash** button to set the wash time.
- Then press the **Rinse** button until the **Rinse** light flashes; press the **Water Level** button to choose the appropriate water level; press the **Rinse** button to set the number of rinses.

To set other processes:

- Then press the **Spin** button until the **Spin** light flashes; press the **Spin** button to set the **Spin** time.
- Finally press the **Start/Pause** button: the washer will start operating according to the set values for wash and rinse water levels, number of rinses and spin time.

Instructions (Cont.)

Fuzzy control

For certain wash programs, the machine automatically detects the weight of your wash load and selects the appropriate wash cycle processes.

- For the **Normal** and **Heavy Duty** programs, the machine will automatically select the correct water power and level, wash and spin time, and rinse type.
- For the **Custom** and **Wool** programs, the machine will automatically select the correct water level. Other wash cycle processes have to be manually set.

Ultrasonic function

This top load washing machine is equipped with an ultrasonic pump, which generates thousands of vibrations per second into the wash tub. These vibrations help remove stains and dirt without chemical stain removers, thus reducing the required detergent amount and wash time.

To select this feature, press and hold the **Preset/Ultrasonic** button for four seconds until the corresponding light comes on and a buzzer sounds. Repeat the steps to cancel. When selecting the **Ultrasonic** wash, please use less detergent than usual.

Memory function

When you run the **Normal**, **Custom** or **Heavy Duty** program, the machine memorises your settings (except for preset time and water level) for the next time you select it.

NOTE: This function is not available for the **Wool**, **Blanket** and **Delicate** programs.

Child lock

With the child lock activated, the machine will stop working automatically and sound an alarm if the washer lid is opened for 4 seconds. To set the child lock:

- Press the **Power** button to switch on the power, then press and hold the **Program** button for 4 seconds until a buzzer sounds. The child lock will be activated when the **Start/Pause** button is pressed. Repeat the steps to cancel.

Start of washing

Washing will start when the water inside the tub has reached two levels below the set level while the water will continue to flow in (see page 15 for the eight water levels).

This early start of washing will increase the wash time and allow the detergent to dissolve fully before the start of the set wash time. This function will be ineffective:

- When water level 1 (28L) or 2 (35L) is selected.
- When the **Delicate** or **Blanket** program is selected.
- When **Soak** is selected, after the soaking process.

FAQs and Troubleshooting

Not all unusual incidents you may encounter with your washing machine are faults, or cause for concern. Check in the list below what issues may arise and why. Also check in the table on the following page for solutions to other common problems.

- **The drain hose is leaking water during the first use. Does this indicate there is a problem?**
No, this is normal; it is residual water from the performance test in the factory and no cause for concern.
- **Why is there still some water intake during the wash or rinse cycle?**
When the water level is low, the washing machine will automatically refill during the washing or rinsing process. This is no cause for concern.
- **At the beginning of the spin cycle, why is the tub turning first and then stopping?**
This is intermittent spinning and it results in better spinning performance.
- **During the spin cycle, why is the machine spinning and then stopping suddenly and taking in water again?**
If the washing is piled up at one side of the tub during the spin cycle, the washing machine automatically takes in more water to redistribute the load. Once the load is balanced again, the spin cycle will continue.
- **Why is there a sound like water flowing after spinning?**
This is the sound of the balancing liquid in the balance ring. This helps reduce vibration during spinning.
- **Why is the control panel still warm after the power is switched off?**
This is caused by the memory circuitry still working.
- **The washer does not work at all. What could I have done wrong?**
 - Check and ensure that the washer is connected properly to the power supply and power is switched on at the outlet.
 - If both are OK, first press the **Power** button, then press the **Start/Pause** button and then press the **Preset** button.
 - If the machine still does not start the set program, check elsewhere in your home whether there has been a power failure, or whether the fuse or circuit breaker has been activated.

If none of the solutions offered above and on the following page help you solve the problem, contact our after sales support centre for advice.

FAQs and Troubleshooting (Cont.)

Error messages

When the following problems occur, the microcomputer inside the washer will detect the abnormal condition. An electronic buzzer will sound for approximately 10 seconds, an error message will flash, as shown below, and the washer will stop operating.

Type of problem	Error message	Where to check
The washer does not work at all.		<ul style="list-style-type: none"> • Check the Power and Start/Pause buttons. • Check whether the machine is under preset condition. • Check whether the power plug is securely plugged in. • Check whether a power failure has occurred. • Check whether the circuit breaker has been activated.
Water does not flow, or only a slim stream flows into the wash/spin tub.	E1	<ul style="list-style-type: none"> • Turn on the water supply tap. • Check whether the water supply has been cut off. • Check whether the water inlet mesh filter is clogged. • Check whether water has frozen in the pipes. • Check whether the water pressure is too low. • Check the height of the drain hose is above 80cm.
Water does not drain out.	E2	<ul style="list-style-type: none"> • Check and make sure the drain hose is properly connected and installed. • Check the drain hose for kinks or obstructions. • Check whether the drain hose is clogged. • Check and ensure that the drain hose is between 80cm and 120cm off the ground. • Check whether the filter of the drain pump is clogged. • Check the lint filter bag inside the drum is clean. • Check the lint filter at the lower back of the machine is not obstructed.
The washer does not spin.	E3	<ul style="list-style-type: none"> • Check whether the washing is piled at one side of the tub. If so, redistribute the load evenly inside the tub. • Check and make sure the washer is installed on an even, level surface.
	E4	<ul style="list-style-type: none"> • Close the washer lid.
The washer does not wash.	E5	<ul style="list-style-type: none"> • Check whether the child lock is set. • Close the washer lid.
Other problems	EA EC	<ul style="list-style-type: none"> • Turn off the power at the machine, then contact our after sales support line to arrange a service.

NOTE: Press the **Start/Pause** button once to release the emergency stop and cancel the error message; press it again to restart the operation.

Other Useful Information

Cleaning and care

To prolong the service life of the washing machine, keep it in good condition and perform regular maintenance. **For any type of cleaning and maintenance, make sure the washing machine is disconnected from the mains power supply.**

Cleaning the washing machine (when required)

- Use a soft cloth to wipe any water or dirt off the washer lid and housing. If using a damp cloth, squeeze it almost dry to avoid leaving water residues.
- The detergent box may be pulled out for cleaning, if required. Other inside parts should be wiped with a damp cloth, if necessary.
- Do not use any chemical, alkaline or abrasive cleaning agents to avoid damaging the surface. Do not spray water directly onto the washer housing.

IMPORTANT!

If you frequently use a COLD wash cycle, you will need to clean the inside of your washing machine regularly (every three months), especially if you use a fabric softener. Liquid detergents can cause detergent scum to build up around the outside of the inner tub, which cold water will not remove and which can cause bacteria, unpleasant odours, and eventually soiling of your wash load.

To remove scum build-up from the inside of a washing machine, run a cleaning cycle without clothes using the **Heavy Duty** program and **hot** water.

As a cleaning agent, use a commercially available washing machine cleaning product (according to the instructions on the product), or use a mix of bicarbonate of soda (½ cup) and white household vinegar (2 cups).

Other Useful Information (Cont.)

Cleaning the lint filter (suggested interval: every week)

Take out the lint filter as illustrated below. Open the filter and rinse it clean under running water, taking care not to damage any parts. Reinstall the filter, making sure it fits securely behind the cover clasp and latches and locks securely into place.

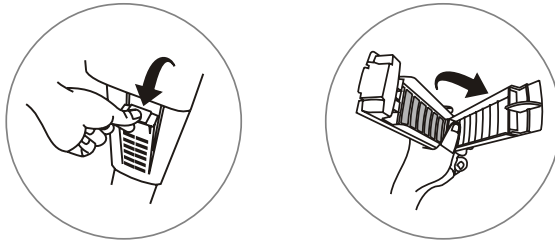

Cleaning the water inlet valve (suggested interval: every 6 months)

To avoid blockage of the mesh filter at the water inlet after long time use, detach the water inlet hose, making sure you have turned off the water supply at the taps beforehand. Take the mesh filter out of the water inlet valve and clean the filter with a soft brush. Then assemble the mesh filter back into the valve and reconnect the water inlet hose.

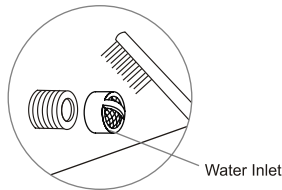

Cleaning the hose filter (suggested interval: every 6 months)

To avoid blockage of the hose filter after long time use, detach the water inlet hose, making sure you have turned off the water supply at the taps beforehand. Turn the nut anticlockwise to take off the hose, clean the filter under running water or with a soft brush, then reconnect the hose.

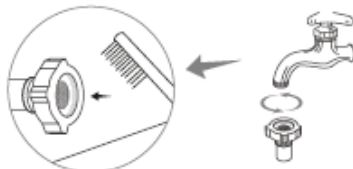

Other Useful Information (Cont.)

Drain pump maintenance

We recommend that you clean the drain pump filter regularly (at least once a month) to avoid blockages created by bobby pins, coins and excess lint.

Proceed as follows:

1. Disconnect the washer from the power source.
2. If necessary, wait until the water has cooled down.
3. Place a container underneath the pump opening to collect any spillage (see below, left).
4. Turn the filter cap anticlockwise to take it out gently (see below, right). Always keep a rag nearby to dry up water spillage when removing the pump filter.

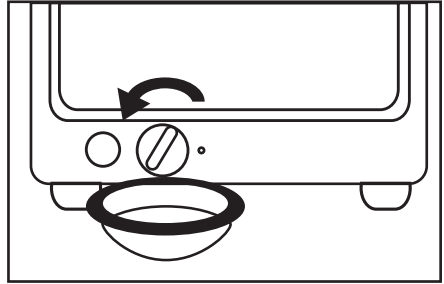
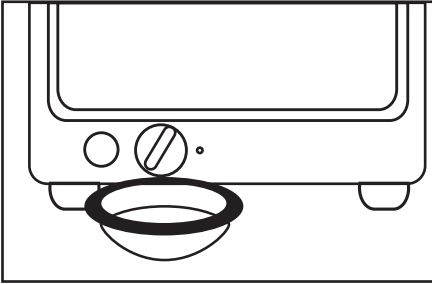

5. To remove any objects from the filter, wash it thoroughly in a basin or under running water (see below, left).
6. Put the cap back and place the filter back in its seat (see below, right).

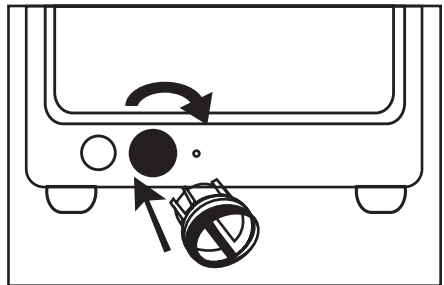

Other Useful Information (Cont.)

Storage

If the appliance is not going to be used for an extended period of time, please unplug the machine from the power supply and disconnect all hoses. Clean the machine and filters as described on the previous pages. Let the machine air-dry thoroughly. Then store it in the original packaging in a dry location, out of reach of children.

Specifications and technical parameters

Dimensions	601 mm (W) x 626mm (D) x 985mm (H)
Capacity (max. weight of dry wash load)	10kg
Weight	47kg
Water quantity (High)	90 litres
Power source	230–240V~, 50Hz
Power consumption	450W
Required water pressure	0.03MPa – 0.8MPa (0.3kgf/cm ² – 8kgf/cm ²)
Liquid ingress protection	IPX4

Compliance

This product has been fully tested and meets all requirements as set out by standards AS/NZS 60335.1 and AS/NZS 60335.2.7.



The RCM Mark (Regulatory Compliance Mark) indicates that the product complies with the relevant guidelines of the ACMA as well as corresponding government requirements for the safety of electrical devices.

WARNING: this appliance must be earthed

In the event of a malfunction or breakdown, earthing will reduce the risk of an electric shock by providing a path of least resistance for the electric current.

This appliance is equipped with a cord having an equipment-earthing conductor and an earthing plug. The plug must be plugged into an appropriate outlet that is installed and earthed in accordance with all local standards and requirements.

WARNING: Do not modify the plug under any circumstances. If the plug does not fit your outlet, consult a licensed electrician and have the outlet changed.

Other Useful Information (Cont.)

Responsible disposal

- Packaging materials are recyclable. Please keep them for future use, or dispose of them responsibly for recycling.
- At the end of its working life, do not throw this appliance out with your household rubbish. Electrical and electronic products contain substances that can have a detrimental effect on the environment and human health if disposed of inappropriately. Observe any local regulations regarding the disposal of electrical consumer goods and dispose of it appropriately for recycling. Contact your local authorities for advice on recycling facilities in your area.

NOTE:

Due to continued product improvement, images and illustrations in this manual may vary slightly from the product purchased. All images in this manual are for reference purposes only. Parts are not necessarily pictured to scale.

Warranty returns

Should you for any reason need to return this product for a warranty claim, make sure to include all accessories with the product.

Product does not work?

If you encounter problems with this product, or if it fails to perform to your expectations, make sure to contact our After Sales Support Centre on 0800 836 761 for advice.

For an electronic copy of this manual, please contact our after sales support centre.

Instruction Manual Revision Index

Version No	Issue Date	Description
V1.0	11 April 2019	Original release

After Sales Support

☎ (AU) 1300 886 649 (NZ) 0800 836 761 | ✉ info@tempo.org